

PCY-4-32-3

УСТРОЙСТВО РАСПРЕДЕЛЕНИЯ
МОЩНОСТИ

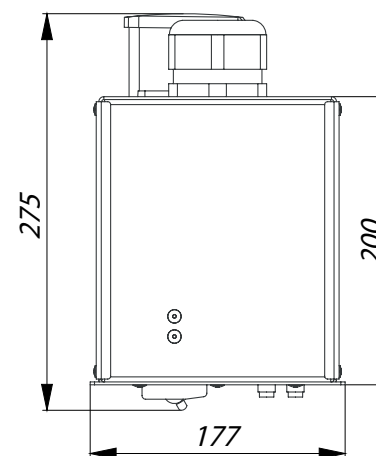
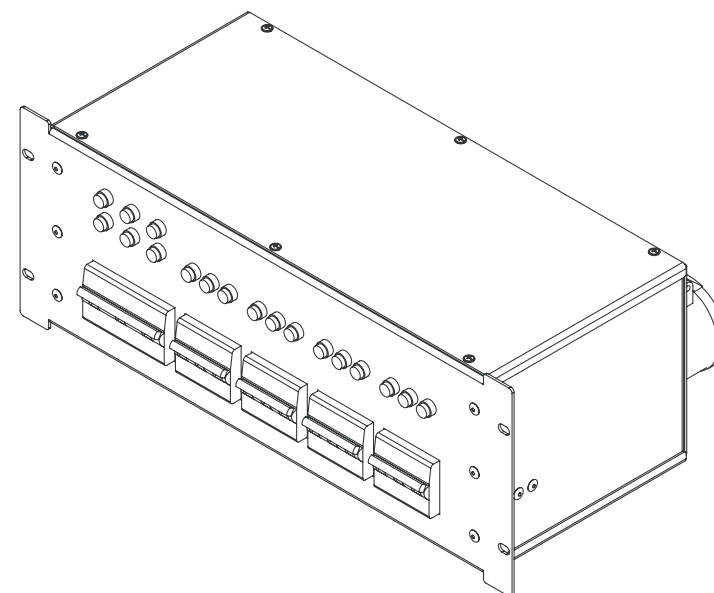
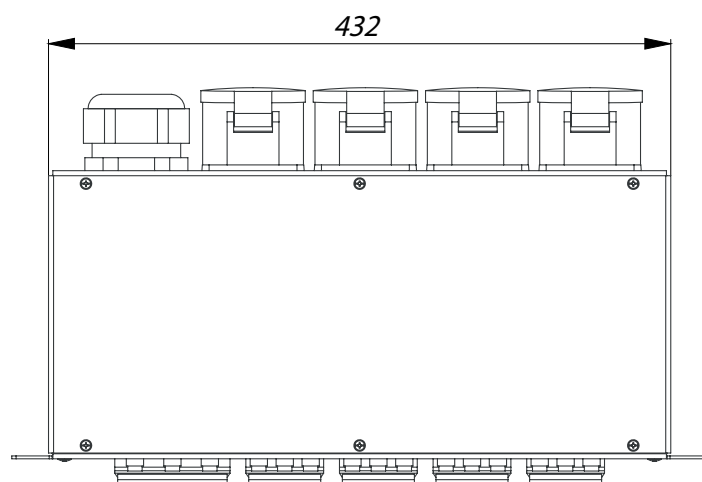
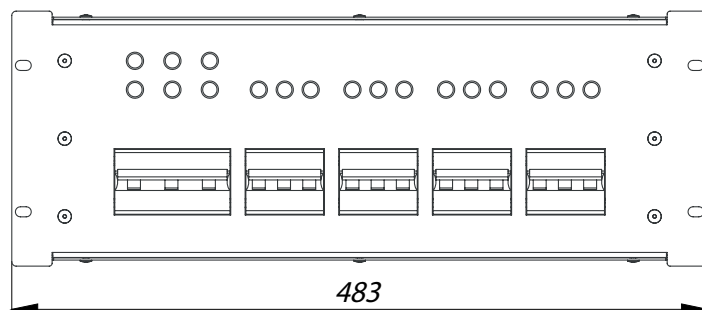

www.equivalent.pro